

LOCKER CH 3/6 F

1	SK	Montážny návod
2	CZ	Montážní návod
3	DE	Montageanleitung
4	ENG	Assembly instructions
5	PL	Instrukcja montażu
6	RO	Instrucțiuni de montaj

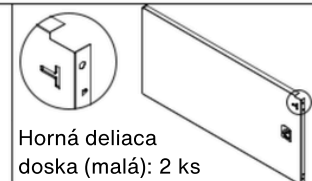

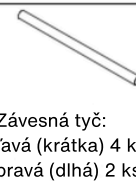
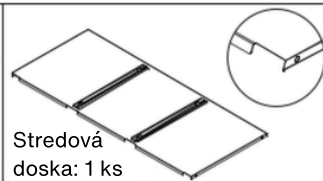
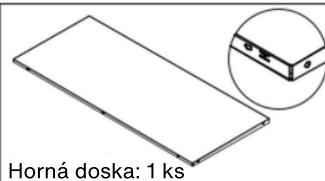

Ľavá strana: 1 ks

Pravá strana: 1 ks

Rám dverí: 1 ks

Zadná doska: 1 ks

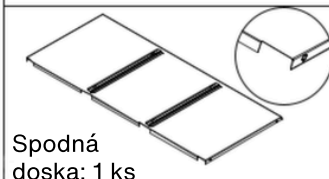

Spodná doska: 1 ks



Samorezné skrutky (5x10): 34 ks

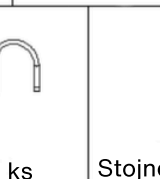

Háčiky: 12 ks



Stojné nohy: 4 ks

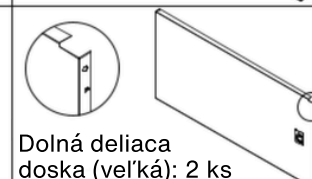

Dolná deliaca doska (veľká): 2 ks

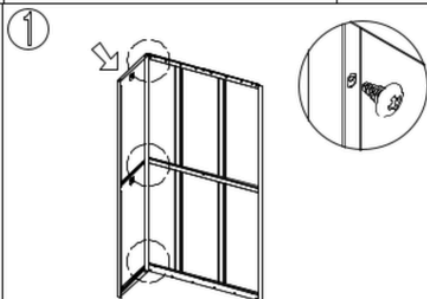
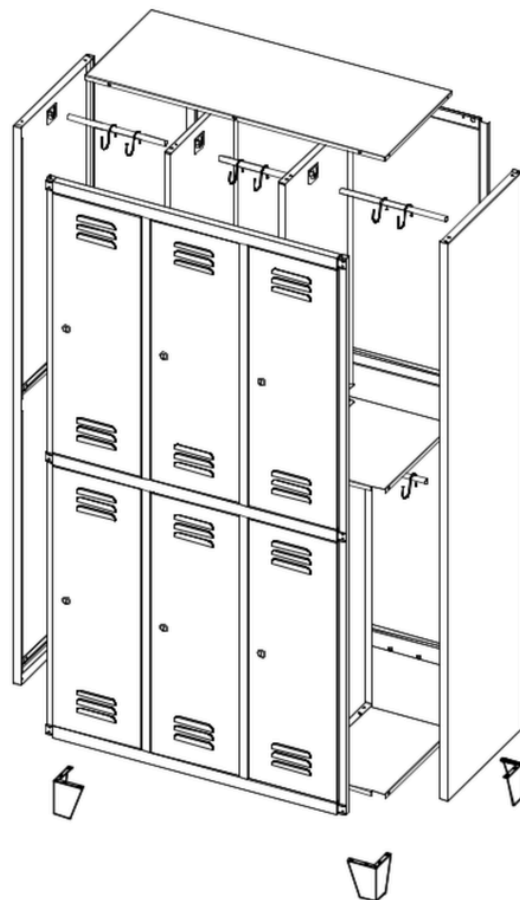

1 Pripevnite ľavú stranu k zadnej doske pomocou samorezných skrutiek (5x10).

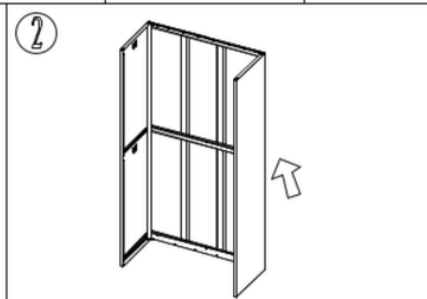

2 Rovnakým spôsobom pripevnite pravú stranu k zadnej doske.

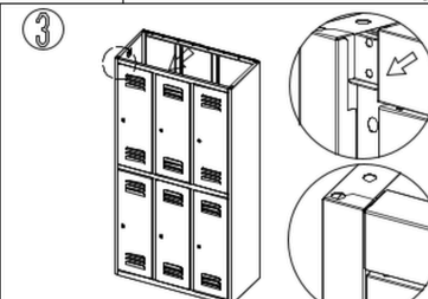

3 Upevnite rám dverí na obe bočné dosky.

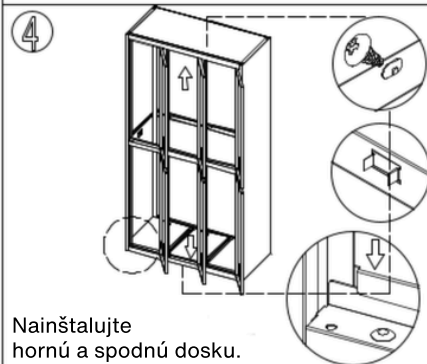

4 Nainštalujte hornú a spodnú dosku.

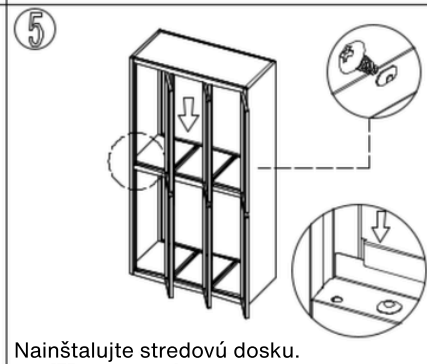

5 Nainštalujte stredovú dosku.

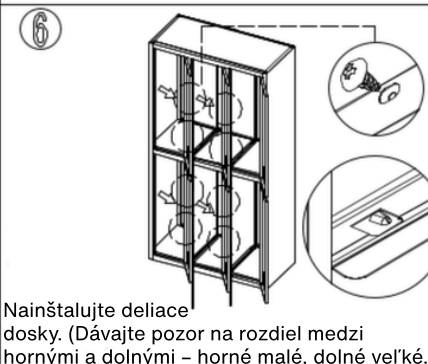

6 Nainštalujte deliace dosky. (Dávajte pozor na rozdiel medzi hornými a dolnými - horné malé, dolné veľké.)

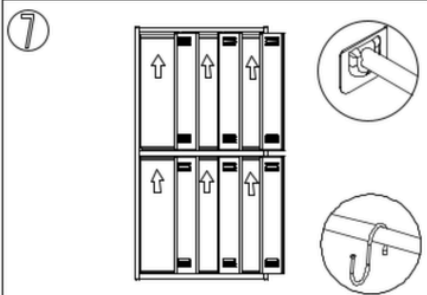

7 Nainštalujte závesnú tyč a háčiky.

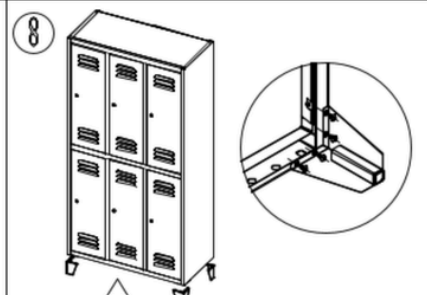

8 Nainštalujte stojné nohy pomocou skrutiek (5x10).



9 Upravte jednotlivé časti tak, aby po montáži všetko správne sedelo.

SK

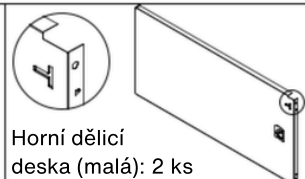
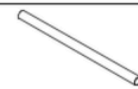
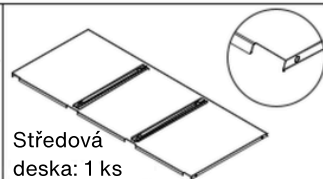
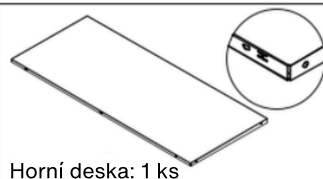

Levá strana: 1 ks

Pravá strana: 1 ks

Rám dveří: 1 ks

Zadní deska: 1 ks

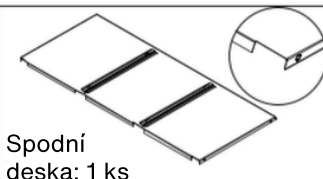

Spodní deska: 1 ks

Samořezné šrouby (5x10): 34 ks

Háček: 12 ks

Stojné nohy: 4 ks

Dolní dělicí deska (velká): 2 ks

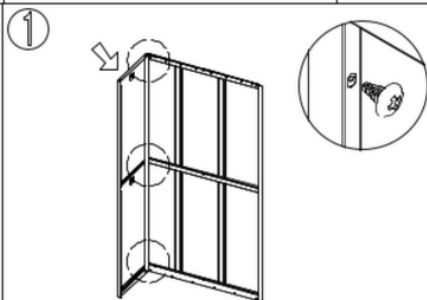
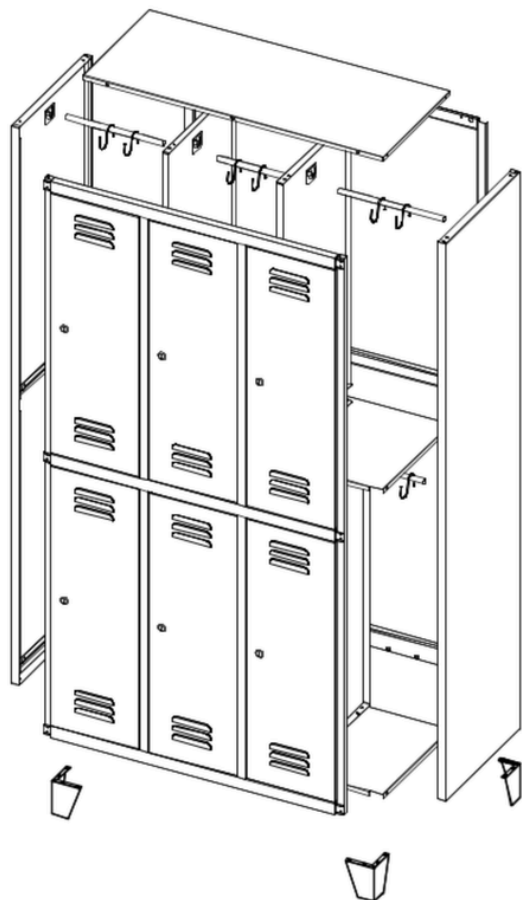

1 Připevněte levou stranu k zadní desce pomocí samořezných šroubů (5x10).

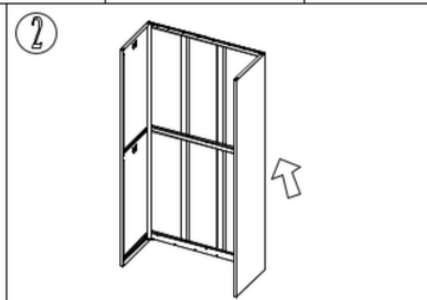

2 Stejným způsobem připevněte pravou stranu k zadní desce.

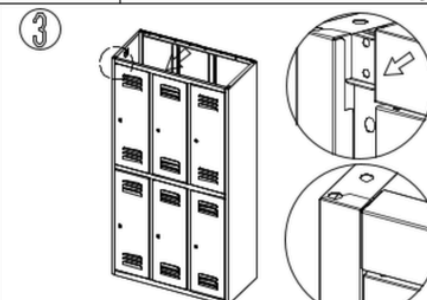

3 Upevněte rám dveří na obě boční desky.

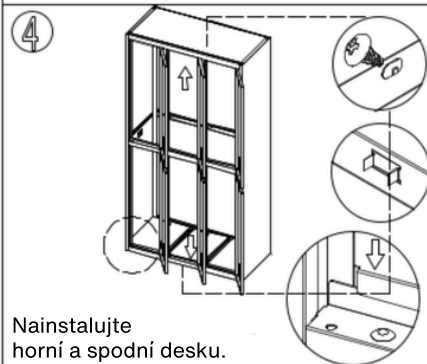

4 Nainstalujte horní a spodní desku.

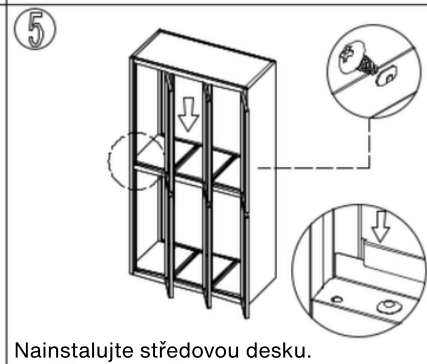

5 Nainstalujte středovou desku.

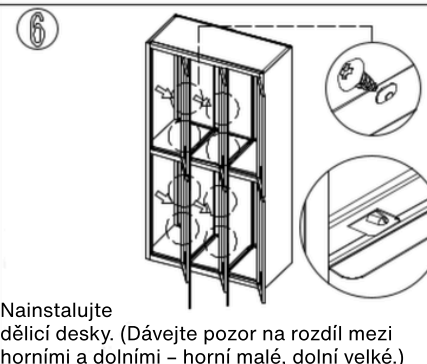

6 Nainstalujte dělicí desky. (Dávejte pozor na rozdíl mezi horními a dolními - horní malé, dolní velké.)

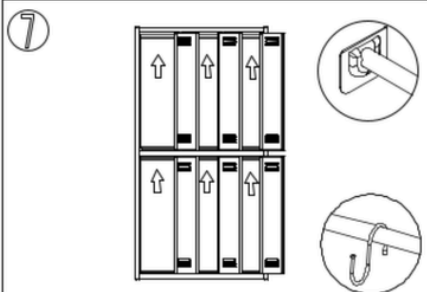

7 Nainstalujte závěsnou tyč a háčky.

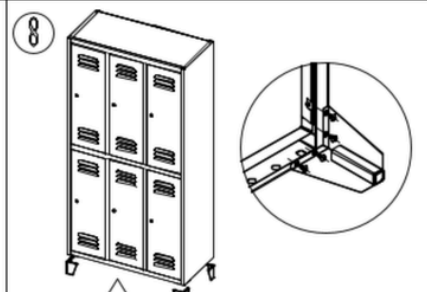

8 Nainstalujte stojné nohy pomocí šroubů (5x10).



9 Upravte jednotlivé části tak, aby po montáži vše správně sedělo.

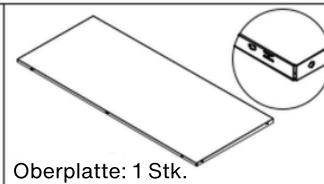

Oberplatte: 1 Stk.

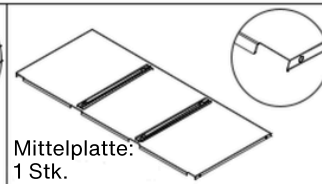

Mittelplatte: 1 Stk.



Kleiderstange:
links (kurz) 4 Stk.
rechts (lang) 2 Stk.



Schlüssel:
6 Sätze

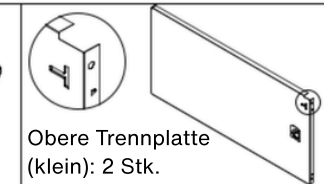

Obere Trennplatte
(klein): 2 Stk.

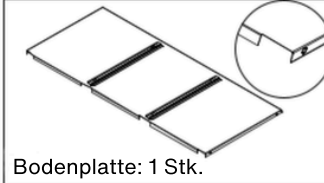

Bodenplatte: 1 Stk.



Selbstschneidende
Schrauben (5x10):
34 Stk.



Haken: 12 Stk.



Standfüße: 4 Stk.

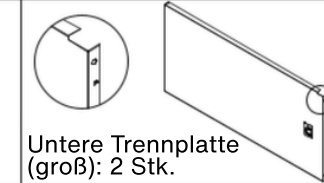

Untere Trennplatte
(groß): 2 Stk.

Linke Seite: 1 Stk.

Rechte Seite: 1 Stk.

Türrahmen: 1 Stk.

Rückwand: 1 Stk.

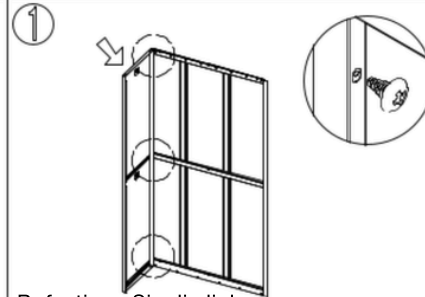
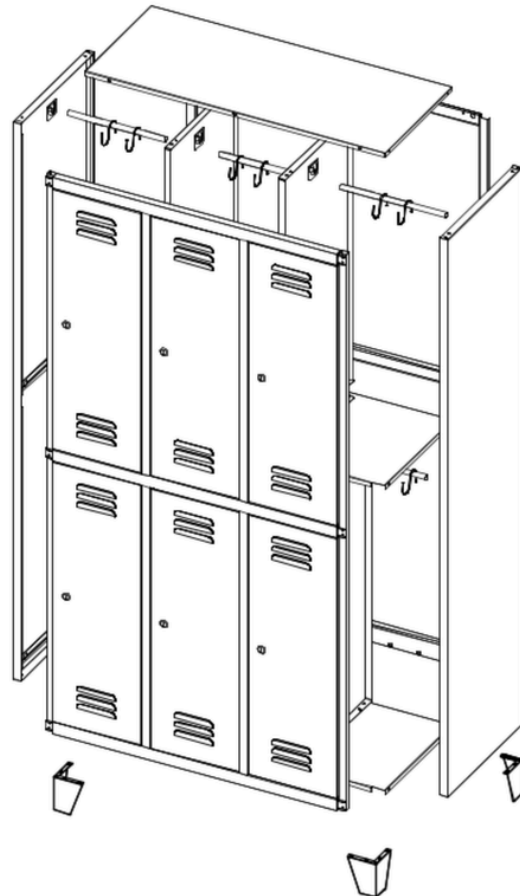

1 Befestigen Sie die linke Seite mit der Rückwand mittels selbstschneidender Schrauben (5x10).

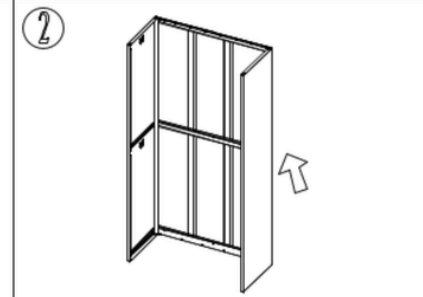

2 Befestigen Sie die rechte Seite auf die gleiche Weise an der Rückwand.

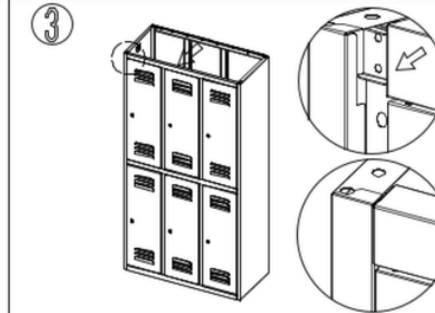

3 Montieren Sie den Türrahmen an beiden Seitenplatten.

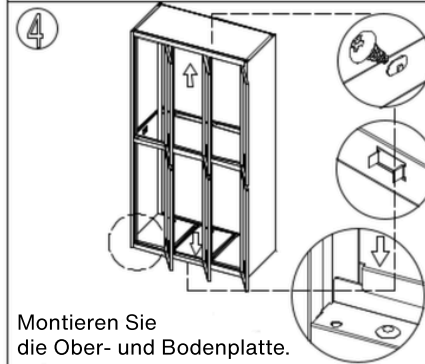

4 Montieren Sie die Ober- und Bodenplatte.

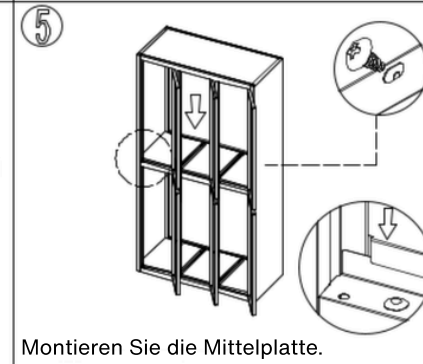

5 Montieren Sie die Mittelplatte.

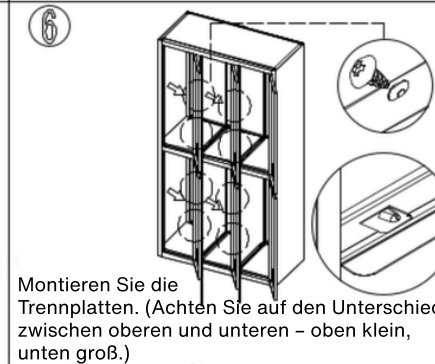

6 Montieren Sie die Trennplatten. (Achten Sie auf den Unterschied zwischen oberen und unteren – oben klein, unten groß.)

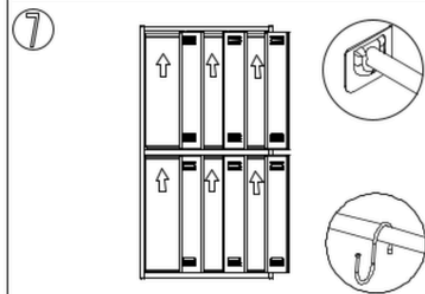

7 Montieren Sie die Kleiderstange und die Haken.

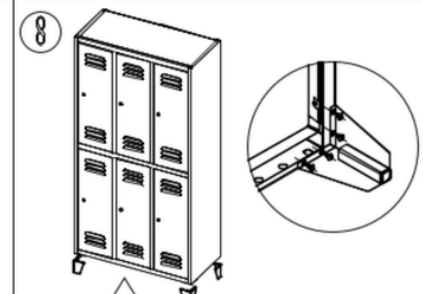

8 Montieren Sie die Standfüße mit Schrauben (5x10).



9 Richten Sie alle Teile so aus, dass nach der Montage alles korrekt passt.

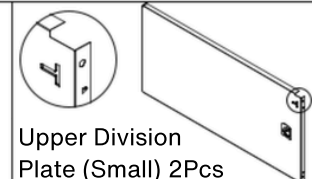
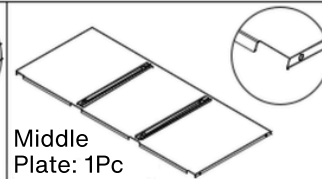
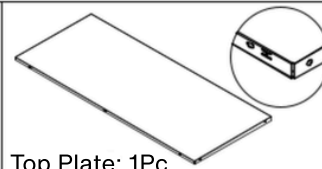

Left Side: 1Pc

Right: Side: 1Pc

Door Frame: 1Pc

Back Plate: 1Pc

Top Plate: 1Pc

Middle Plate: 1Pc

Hanging Rod:
Left (Short) 4Pcs
Right (Long) 2Pcs

Key: 6 Sets

Upper Division
Plate (Small) 2Pcs

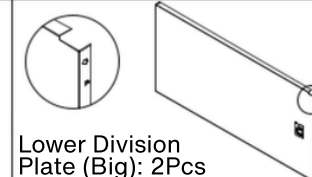
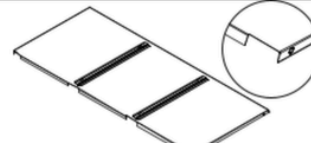

Bottom Plate: 1Pc

Self-tapping Screw
(5x10): 34Pcs

Hook: 12 Pcs

Standing Feet: 4Pcs

Lower Division
Plate (Big): 2Pcs

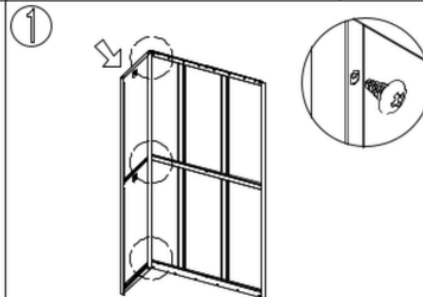
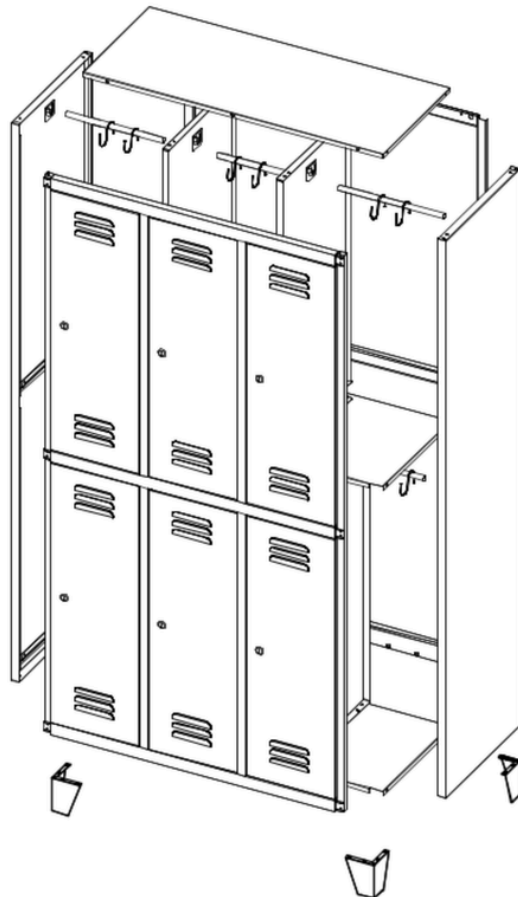

1 Bolt the left side and back plate with self-tapping screws (5x10)

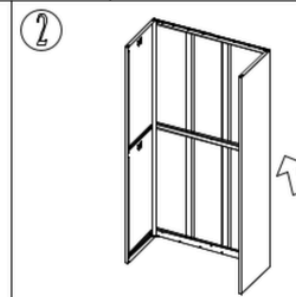

2 Bolt the right side with back plate in the same way as the first step

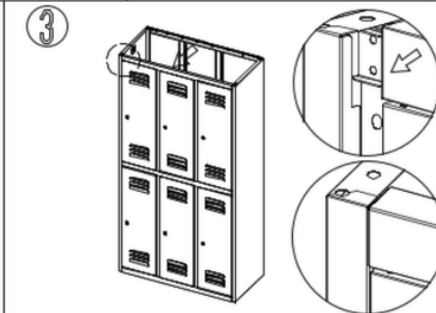

3 Fix the door frame onto both of the side plates

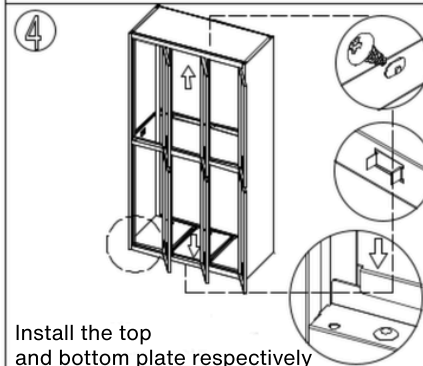

4 Install the top and bottom plate respectively

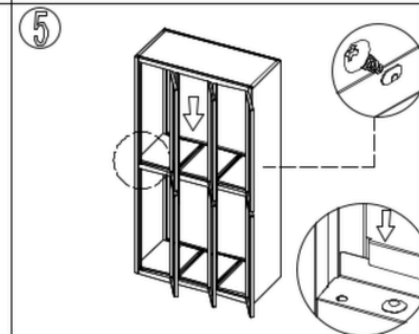

5 Install the middle plates

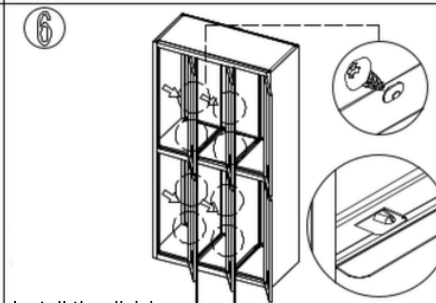

6 Install the division plates. (Pay attention to the difference of upper and lower ones, upper small, lower big.)

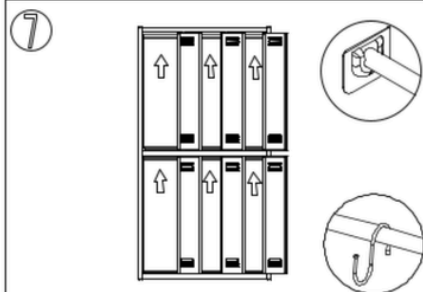

7 Install the hanging rod and hook

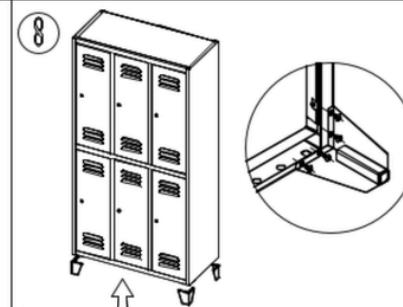

8 Install the standing feet with screws (5x10)

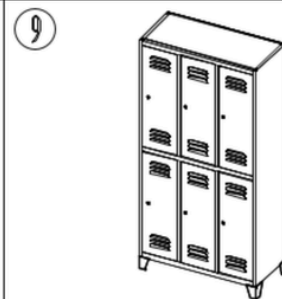

9 Adjust each part till fit well after installation

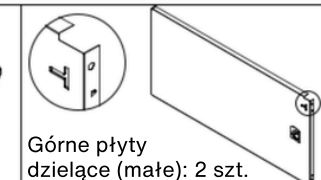
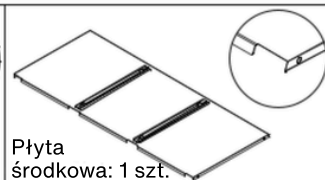
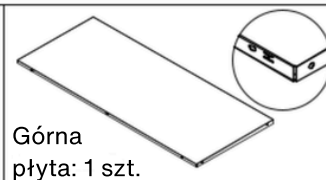

Górna płyta: 1 szt.

Płyta środkowa: 1 szt.

Drażek na ubrania: lewy (krótki) 4 szt. prawy (długi) 2 szt.

Klucz: 6 zestawów

Górne płyty dzielące (małe): 2 szt.

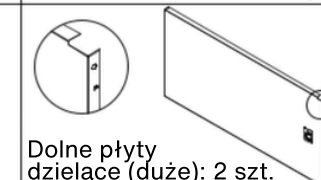
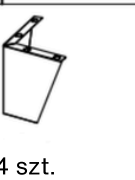
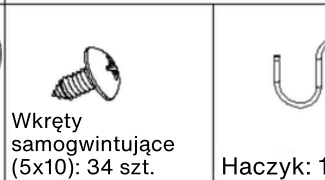
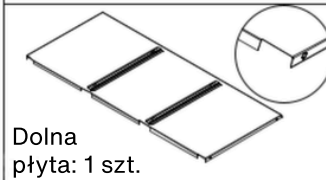

Dolna płyta: 1 szt.

Wkręty samogwintujące (5x10): 34 szt.

Haczyk: 12 szt.

Nóżki: 4 szt.

Dolne płyty dzielące (duże): 2 szt.

Lewa strona: 1 szt.

Prawa strona: 1 szt.

Rama drzwi: 1 szt.

Tylna płyta: 1 szt.

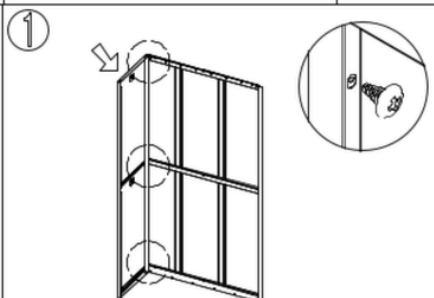
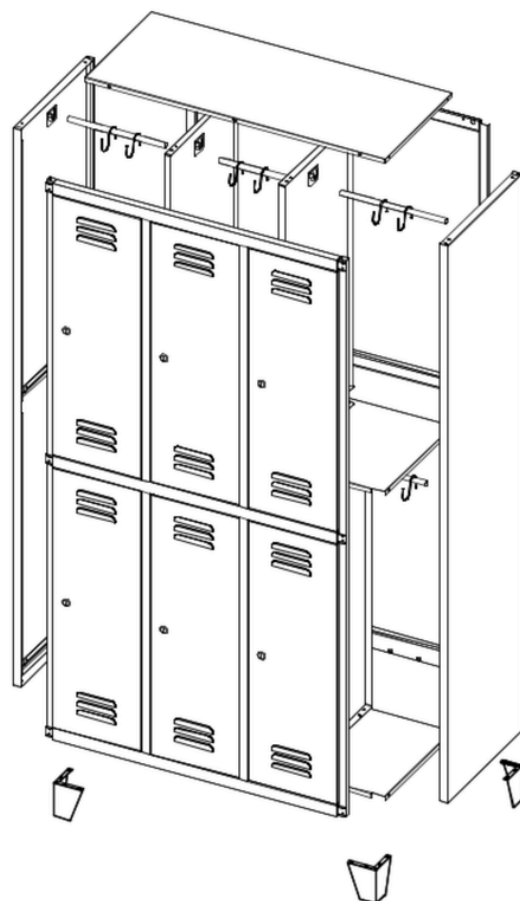

Przymocuj lewą stronę do tylnej płyty za pomocą wkrętów samogwintujących (5x10).

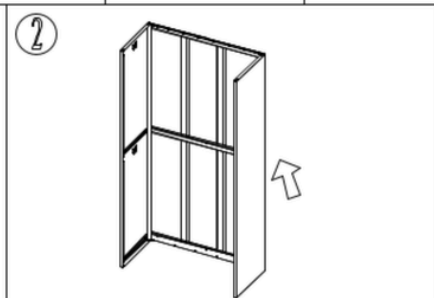

Przymocuj prawą stronę do tylnej płyty w ten sam sposób jak w pierwszym kroku.

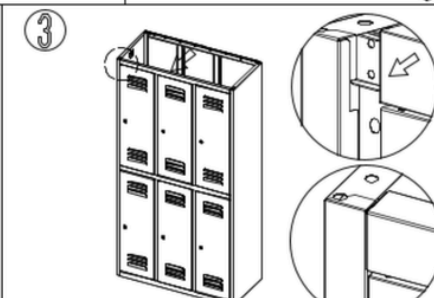

Zamocuj ramę drzwi do obu płyt bocznych.

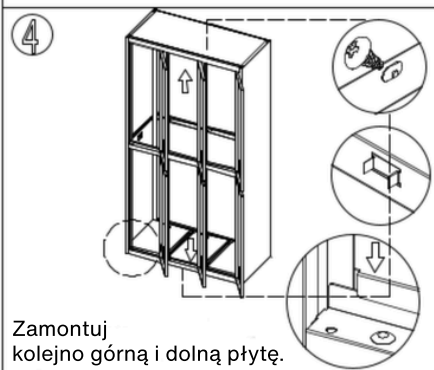

Zamontuj kolejno górną i dolną płytę.

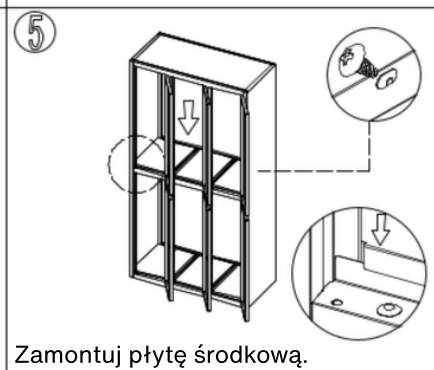

Zamontuj płytę środkową.

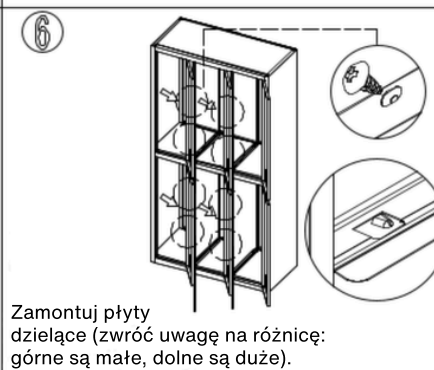

Zamontuj płyty dzielące (zwróć uwagę na różnicę: górne są małe, dolne są duże).

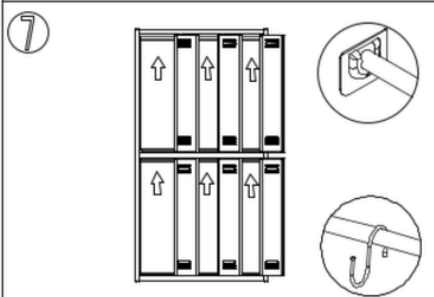

Zamontuj drążki oraz haczyki.

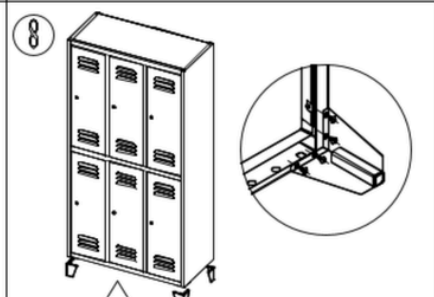

Zamontuj nóżki za pomocą wkrętów (5x10).



Po montażu wyreguluj wszystkie elementy, aby dobrze do siebie pasowały.

PL

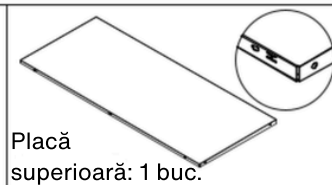

Placă
superioară: 1 buc.

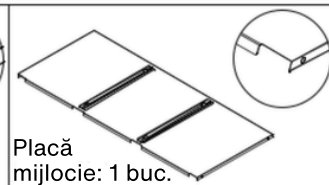

Placă
mijlocie: 1 buc.



Bară de agătat:
stânga (scurtă) 4 buc.
dreapta (lungă) 2 buc.



Cheie: 6 seturi

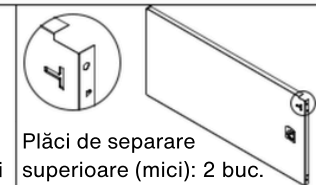

Plăci de separare
superioare (mici): 2 buc.

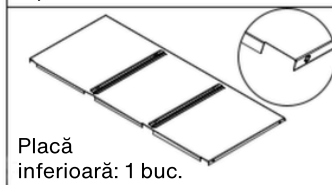

Placă
inferioară: 1 buc.

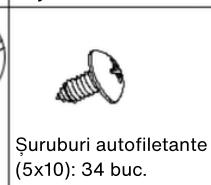

Șuruburi autofiletante
(5x10): 34 buc.

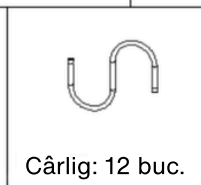

Cârlig: 12 buc.



Picioare: 4 buc.

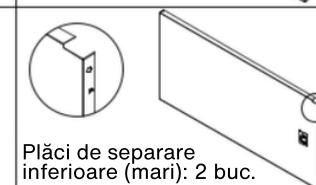

Plăci de separare
inferioare (mari): 2 buc.

Partea stângă: 1 buc.

Partea dreaptă: 1 buc.

Cadru ușă: 1 buc.

Placă spate: 1 buc.

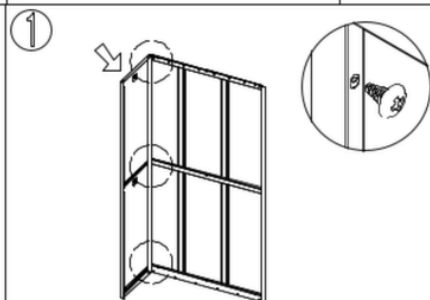
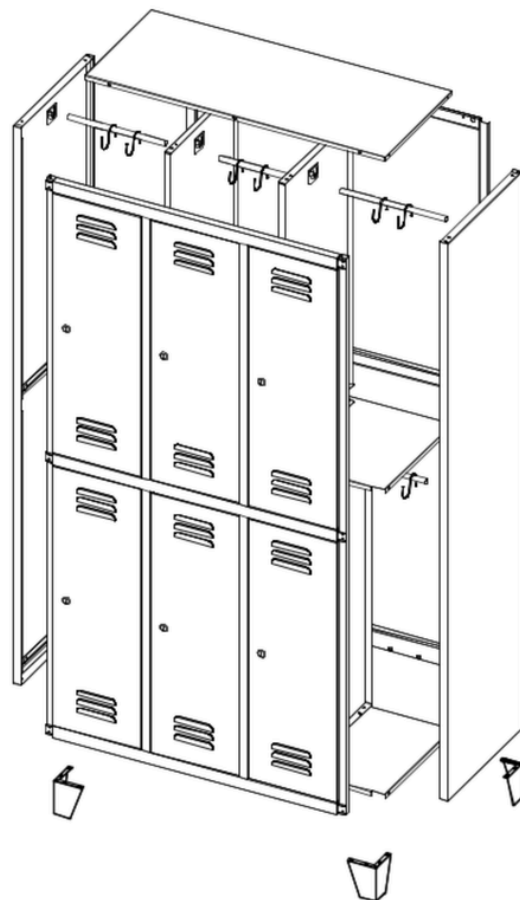

1
Fixați partea stângă de placa din
spate cu șuruburi autofiletante (5x10).

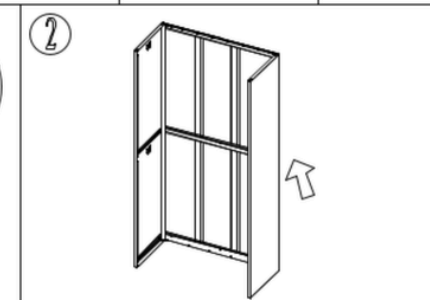

2
Fixați partea dreaptă de placa
din spate în același mod ca la primul pas.

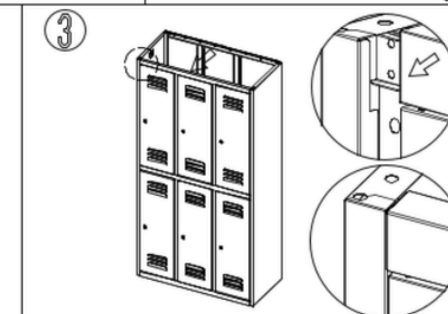

3
Fixați cadrul ușii pe ambele plăci laterale.

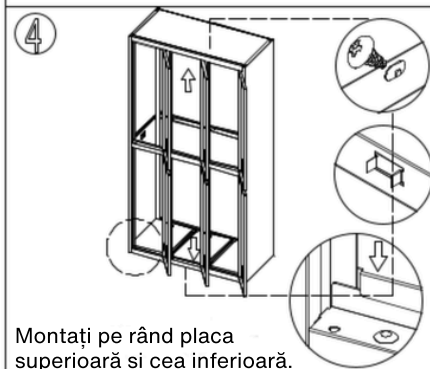

4
Montați pe rând placa
superioară și cea inferioară.

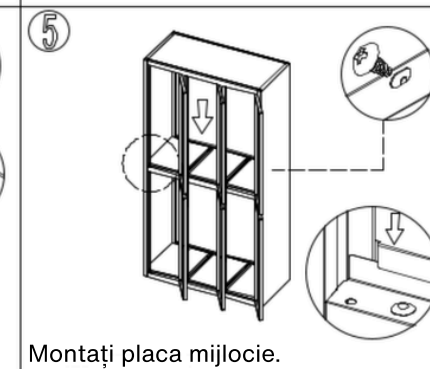

5
Montați placa mijlocie.

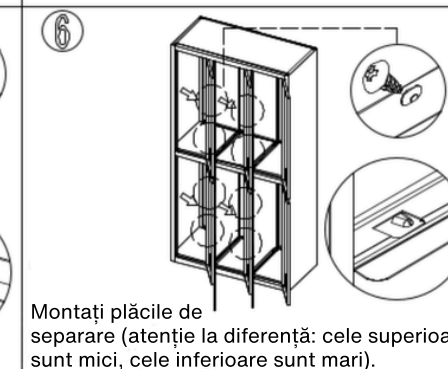

6
Montați plăcile de
separare (atenție la diferență: cele superioare
sunt mici, cele inferioare sunt mari).

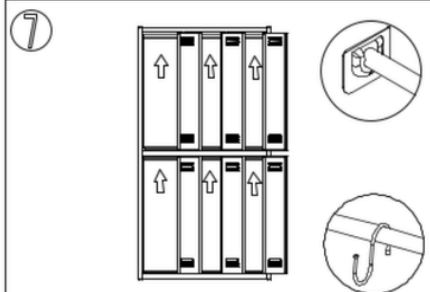

7
Montați barele de agătat și cârligele.

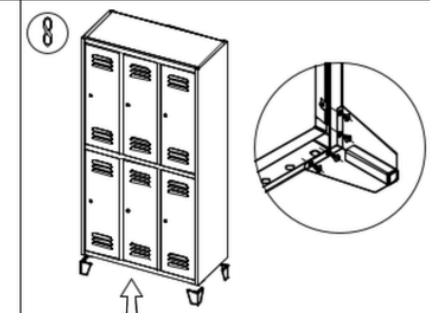

8
Montați picioarele cu șuruburi (5x10).



9
După instalare, ajustați fiecare
componentă pentru a se potrivi corect.